

No.	DATE	REVISIONS
1	3/13/2023	DRT REVIEW & RESPONSE
2	6/16/2023	DRT REVIEW & RESPONSE

**STEAMBOAT AIRPARK
PRELIMINARY PLAT
LOT 1, WEST ACRES RANCH SUBDIVISION
GLORIA GOSSARD PARKWAY
STEAMBOAT SPRINGS, CO 80487**

Horizontal Scale

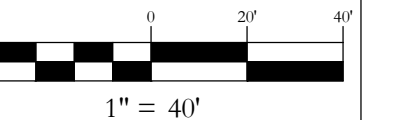

Contour Interval = 2 ft

DATE: 4-22-2022
JOB #: 1670-001
DRAWN BY: MDM
DESIGN BY: MDM
REVIEW BY: RL

IF THIS DRAWING IS PRESENTED IN A
FORMAT OTHER THAN 24" X 36" THE
GRAPHIC SCALE SHOULD BE UTILIZED.

**COPPER RIDGE DRIVE PLAN
VILLAGE DRIVE PLAN
& PROFILE**

DRAWING:

SHEET #

PP11

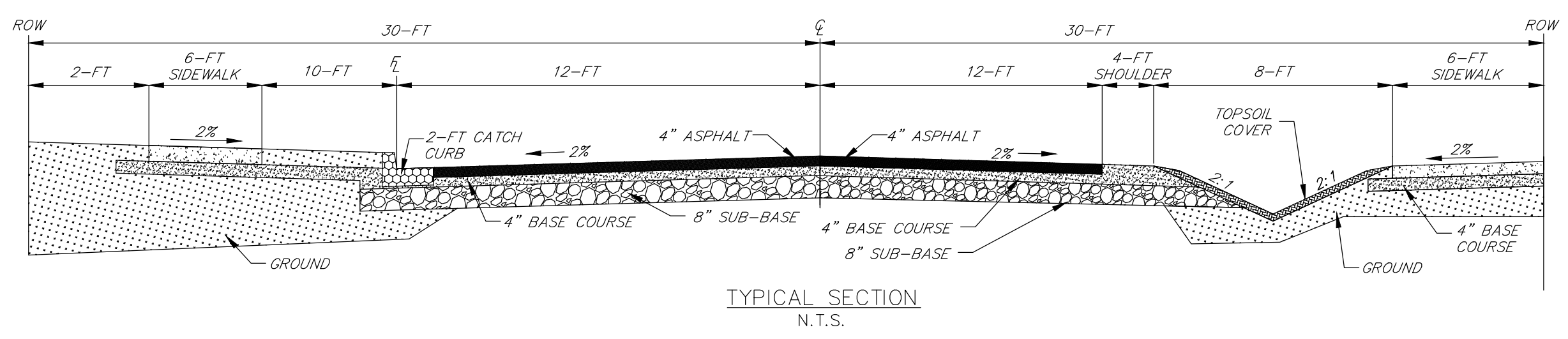
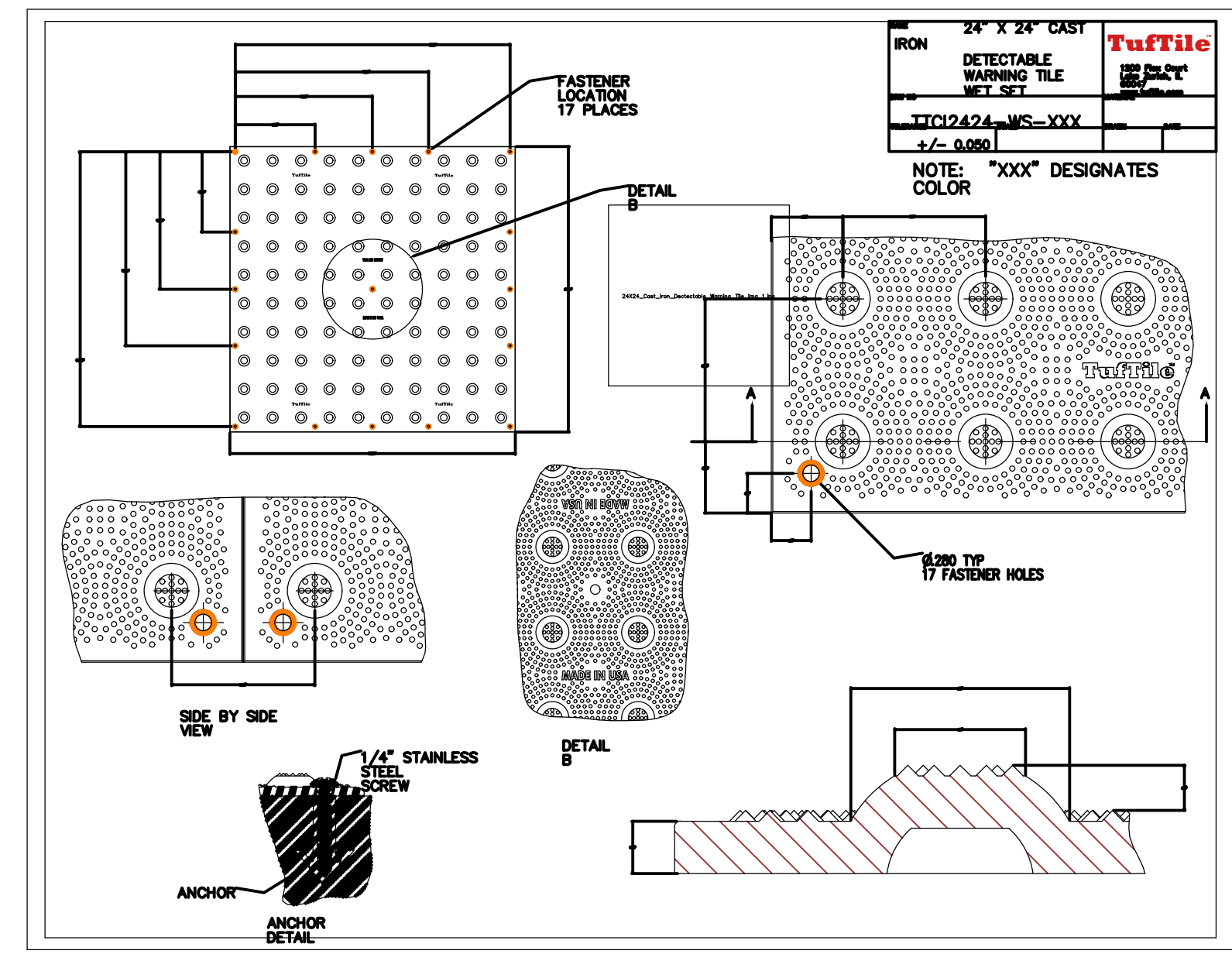
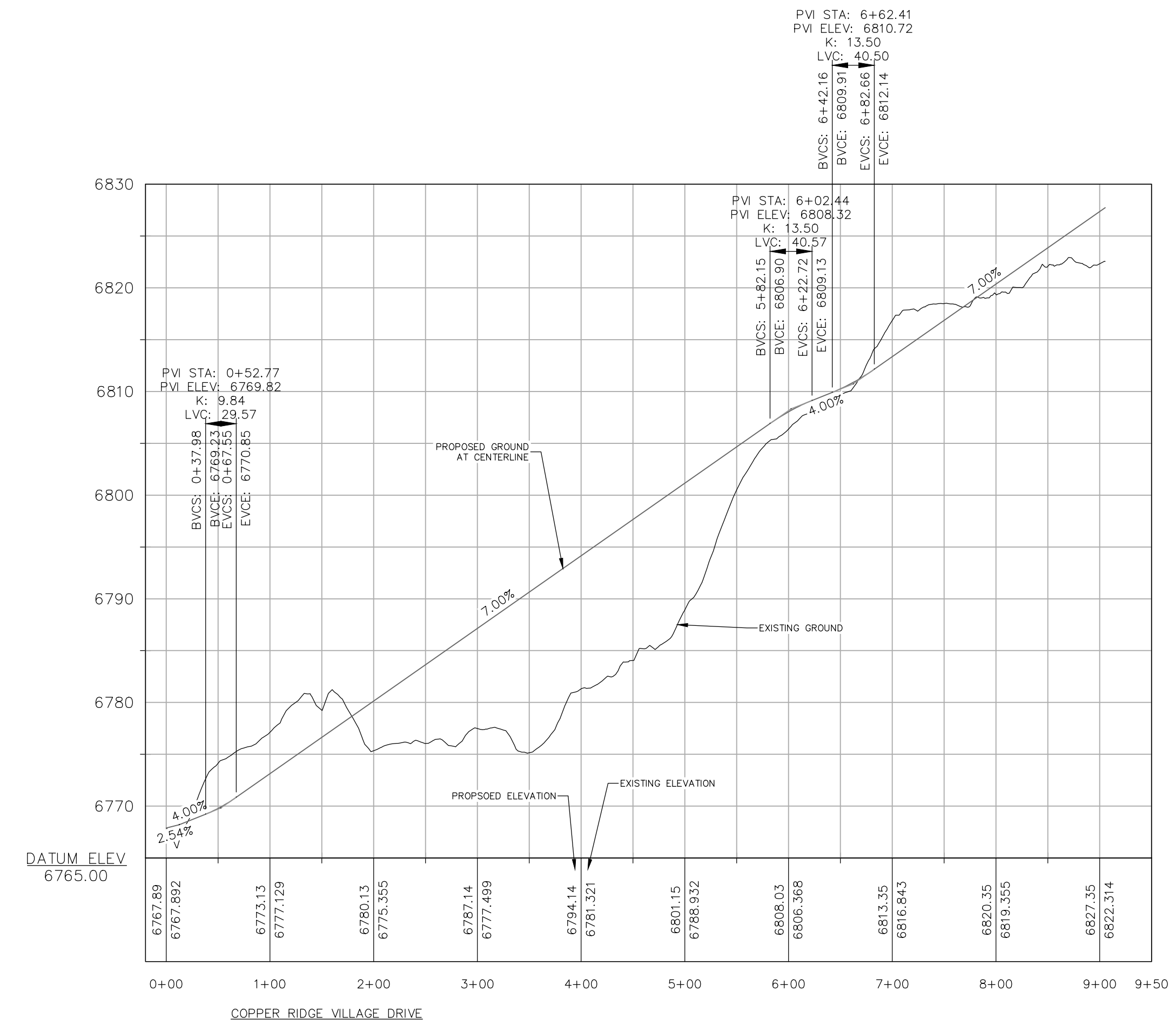
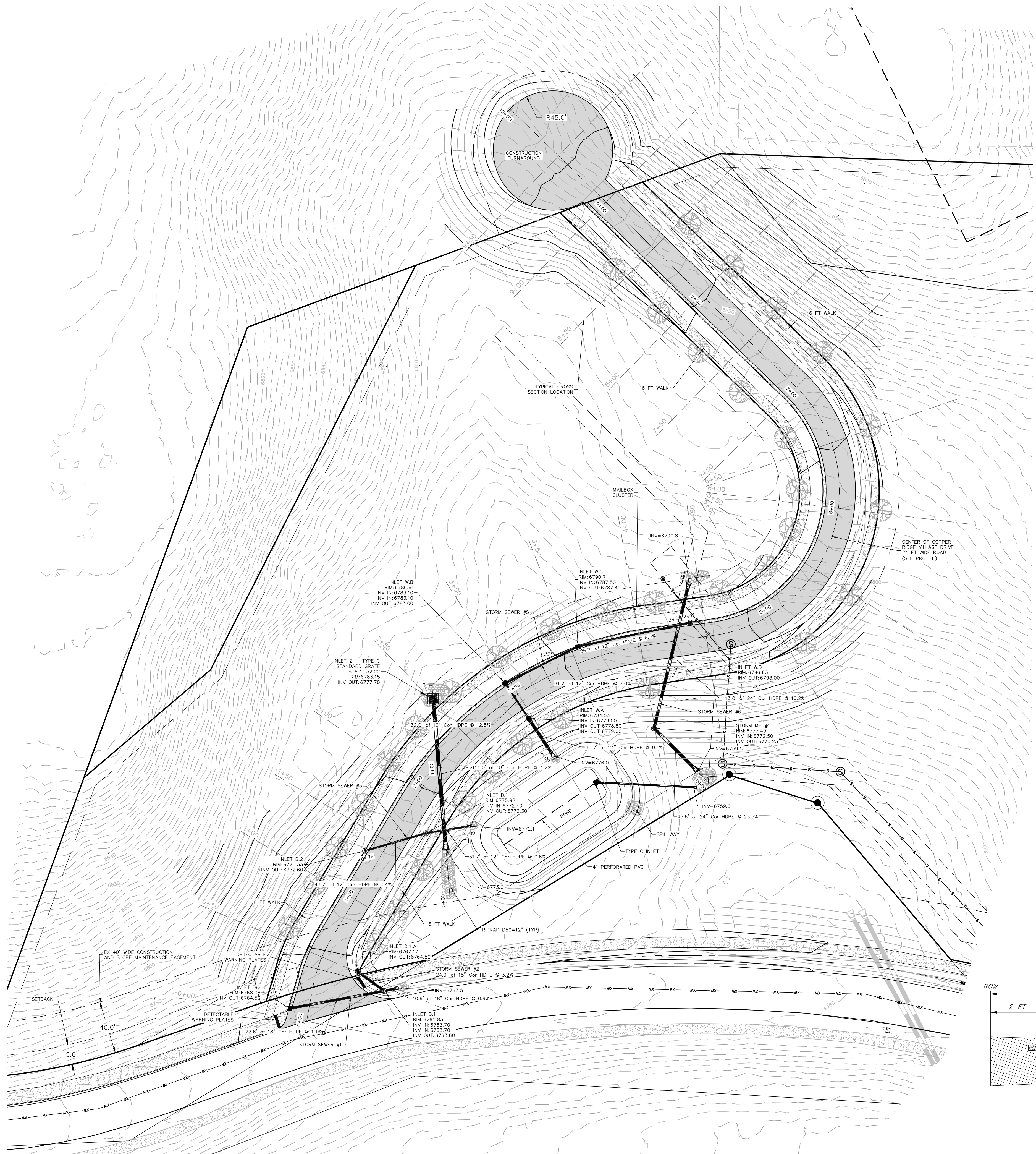

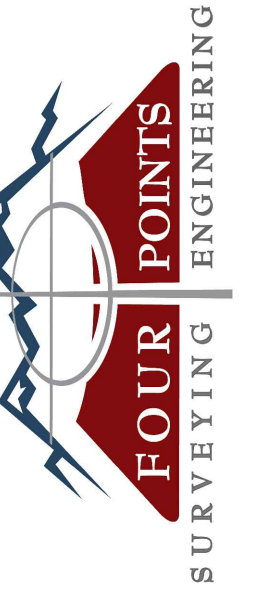

440 S. Lincoln Ave, Suite 4B
P.O. Box 775966
Steamboat Springs, CO 80487
(970)-871-6772
matthew@fourpointse.com

No.	DATE	REVISIONS	
		INT	MDM
1	3/13/2023	DRY REVIEW & RESPONSE	
2	6/16/2023	DRY REVIEW & RESPONSE	

**STEAMBOAT AIRPARK
PRELIMINARY PLAT
LOT 1, WEST ACRES RANCH SUBDIVISION
GLORIA GOSSARD PARKWAY
STEAMBOAT SPRINGS, CO 80487**

Horizontal Scale

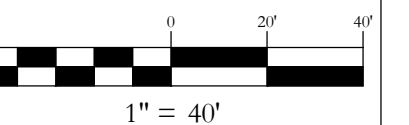

1" = 40'

Contour Interval = 2 ft

DATE: 4-22-2022
JOB #: 1670-001
DRAWN BY: MDM
DESIGN BY: MDM
REVIEW BY: RL

IF THIS DRAWING IS PRESENTED IN A
FORMAT OTHER THAN A4 X 36" THE
GRAPHIC SCALE SHOULD BE UTILIZED.

**COPPER RIDGE
VILLAGE CROSS
SECTIONS**

DRAWING:

SHEET #

PP12

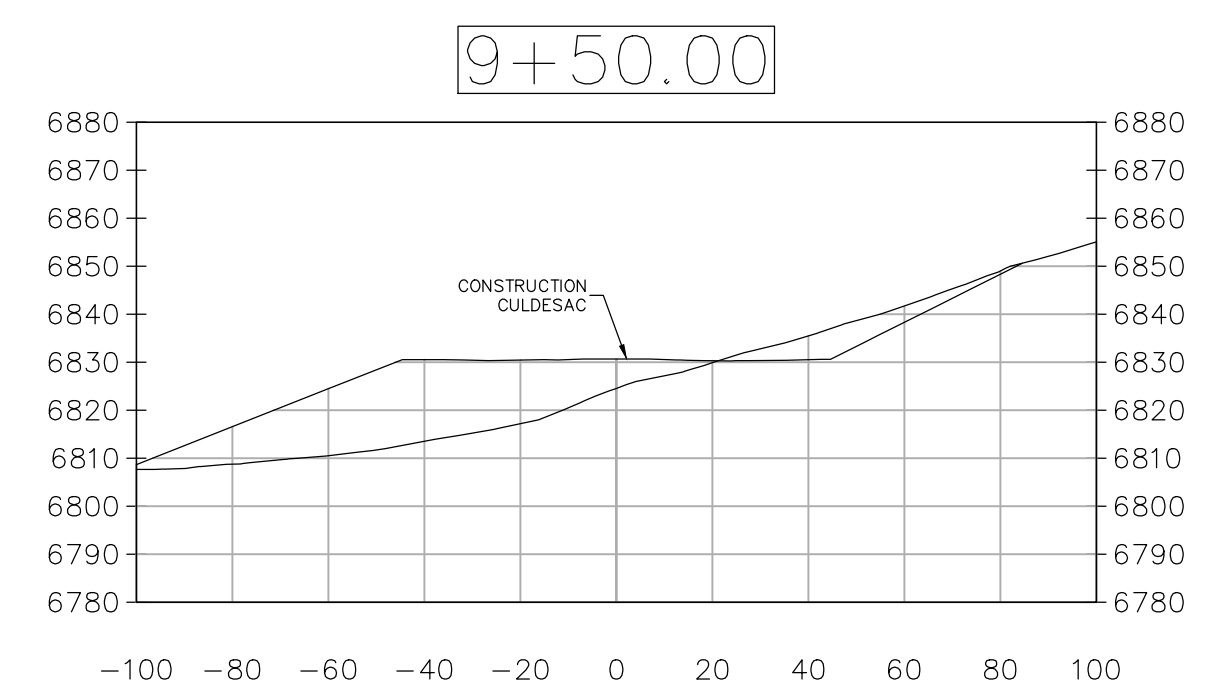
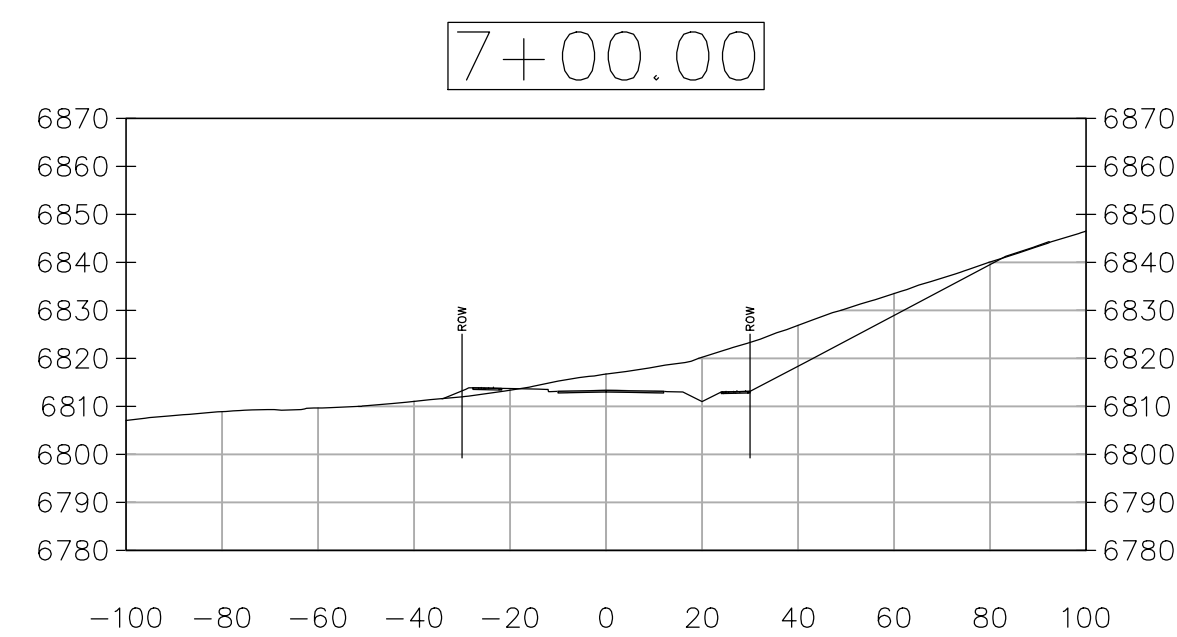
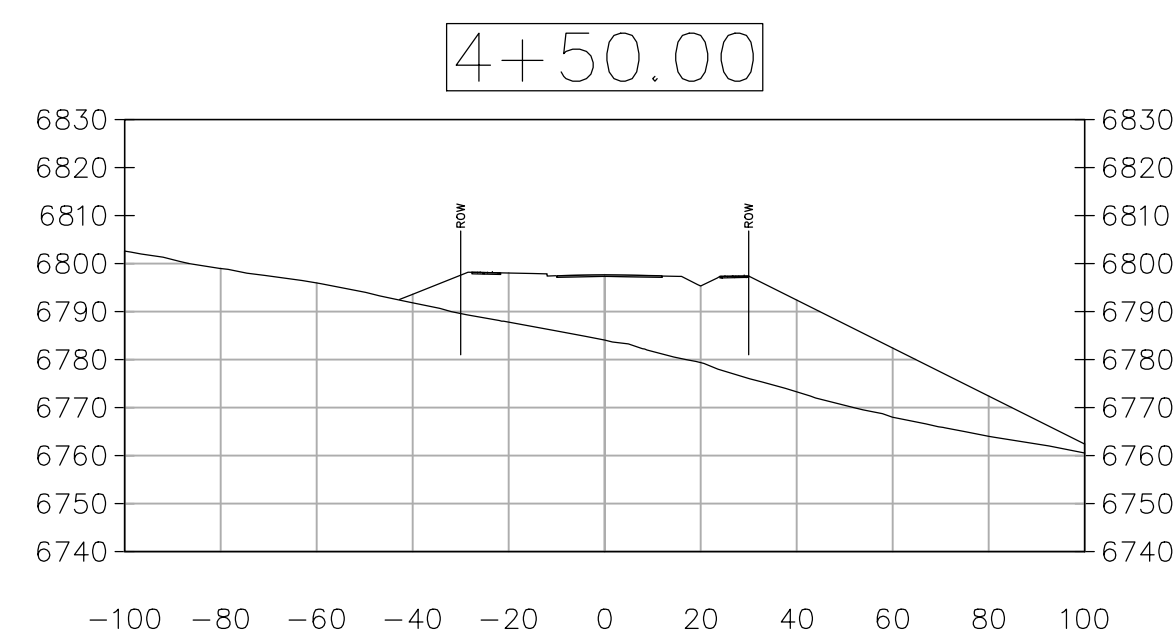
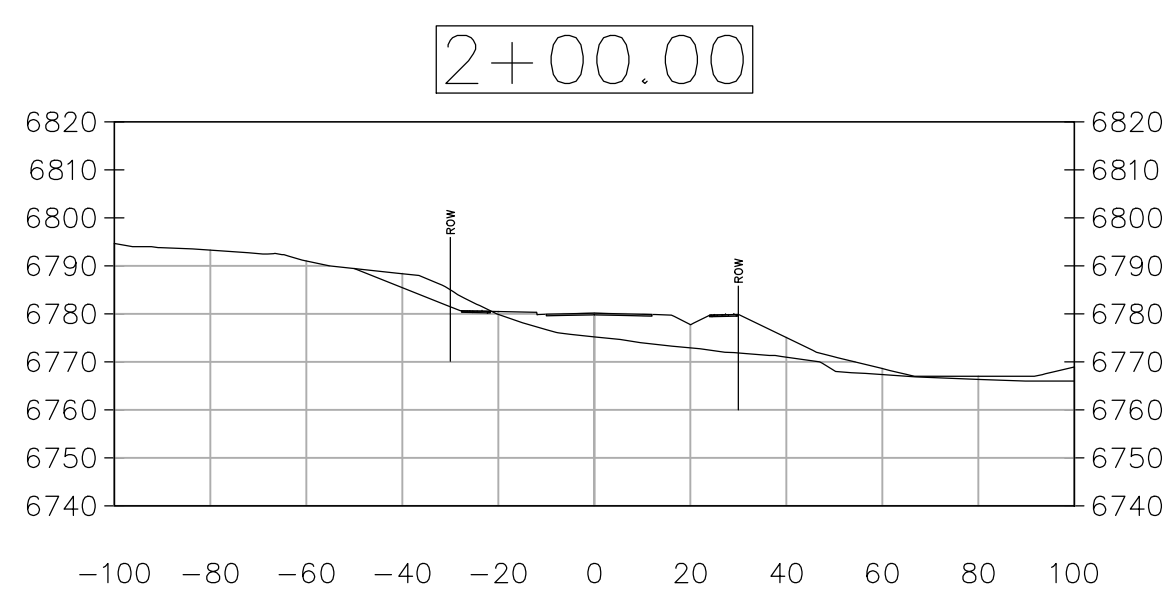
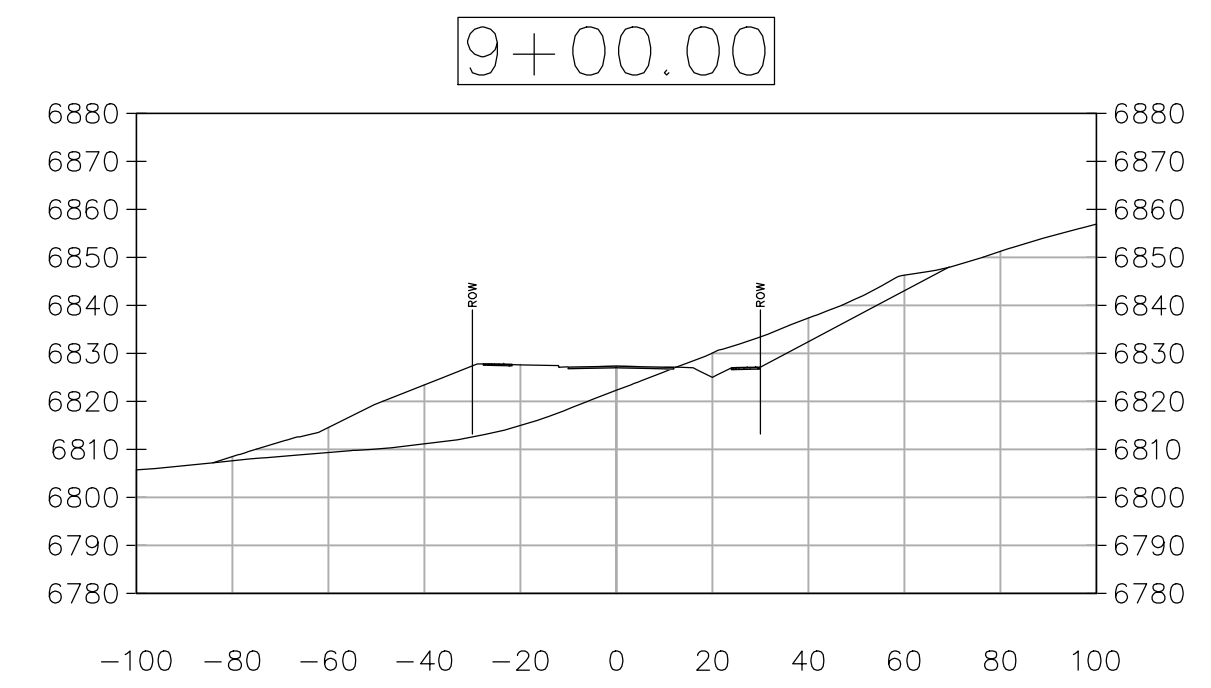
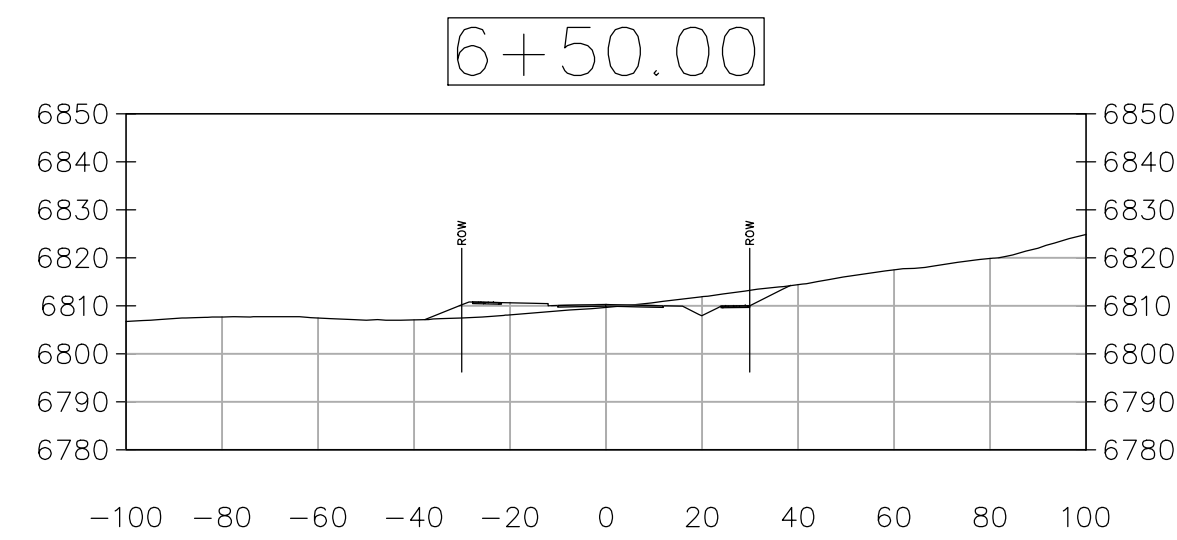
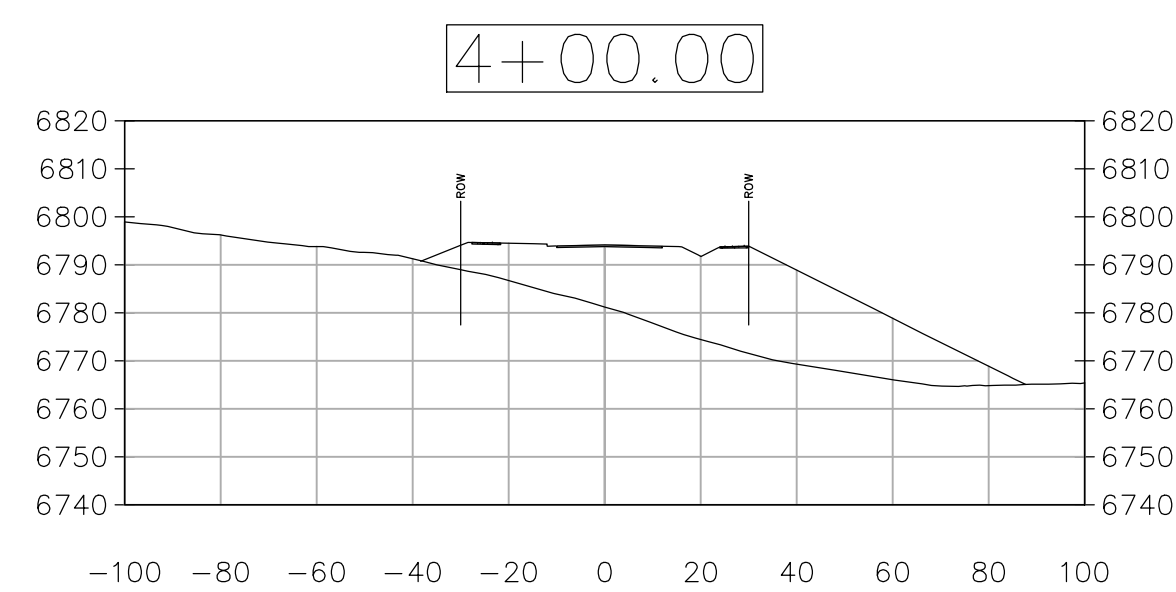
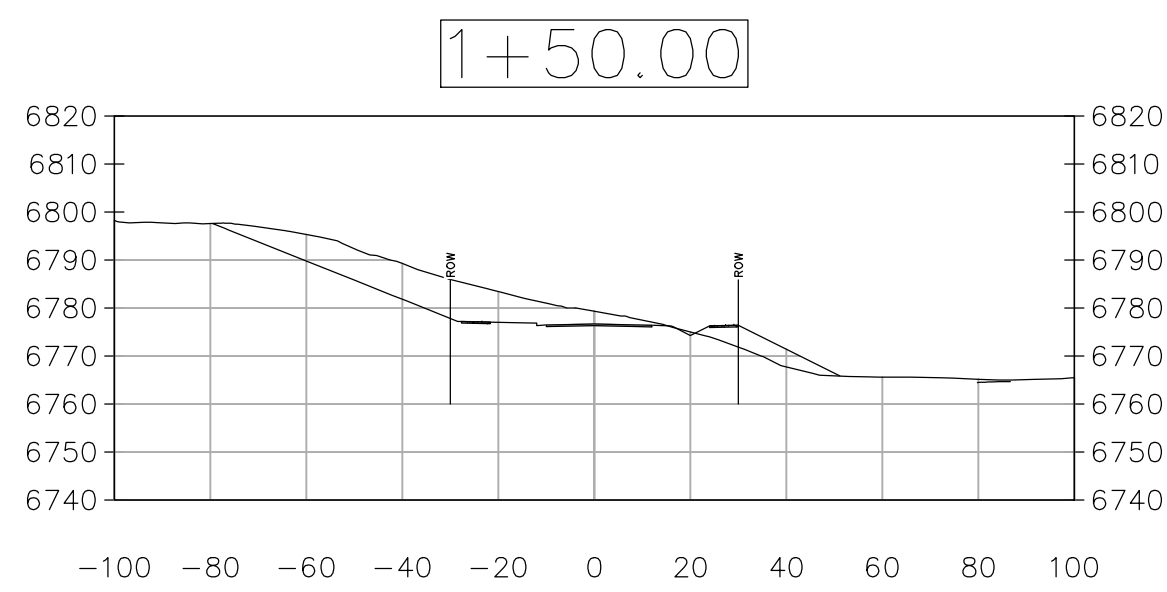
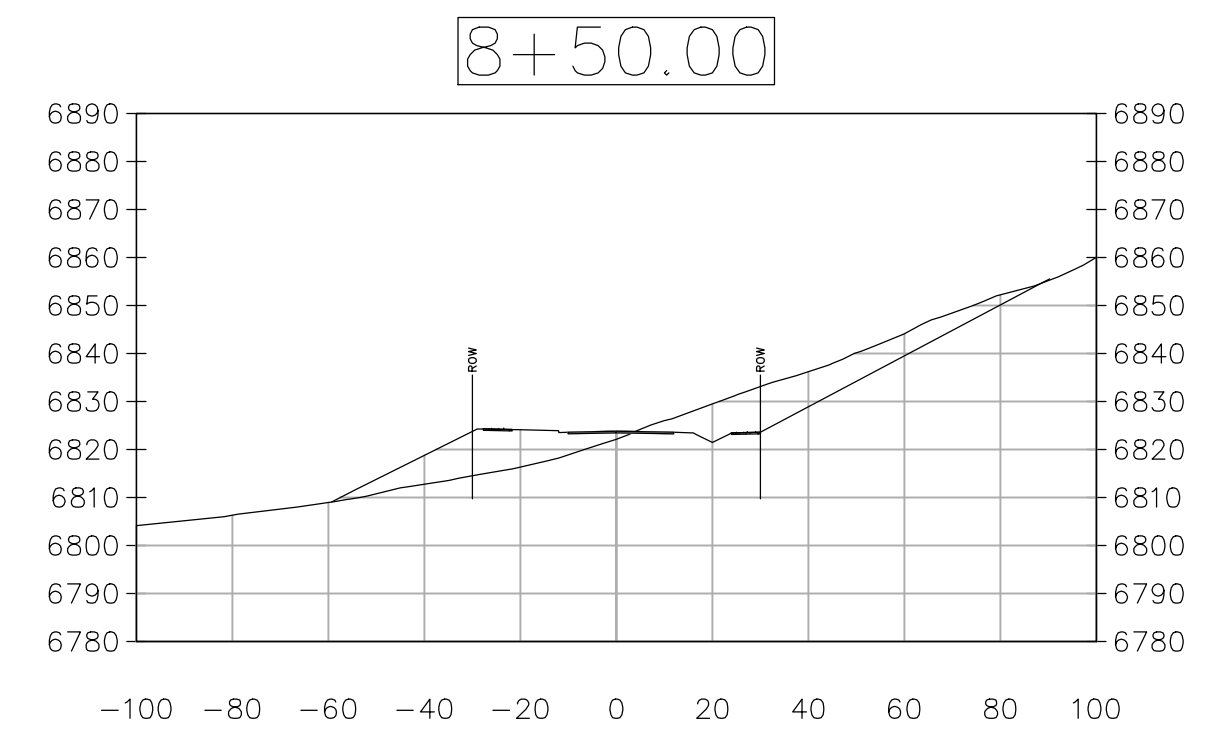
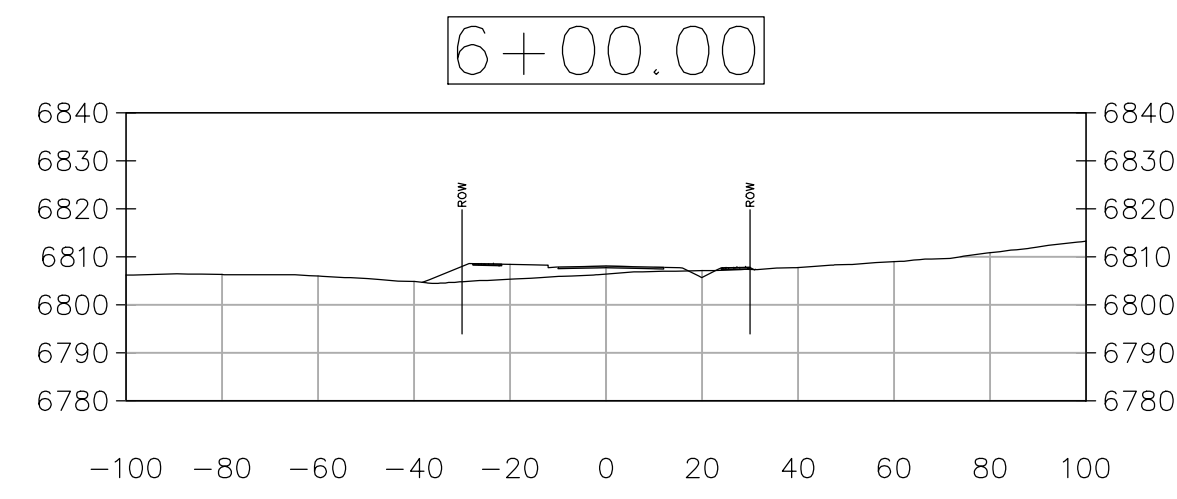
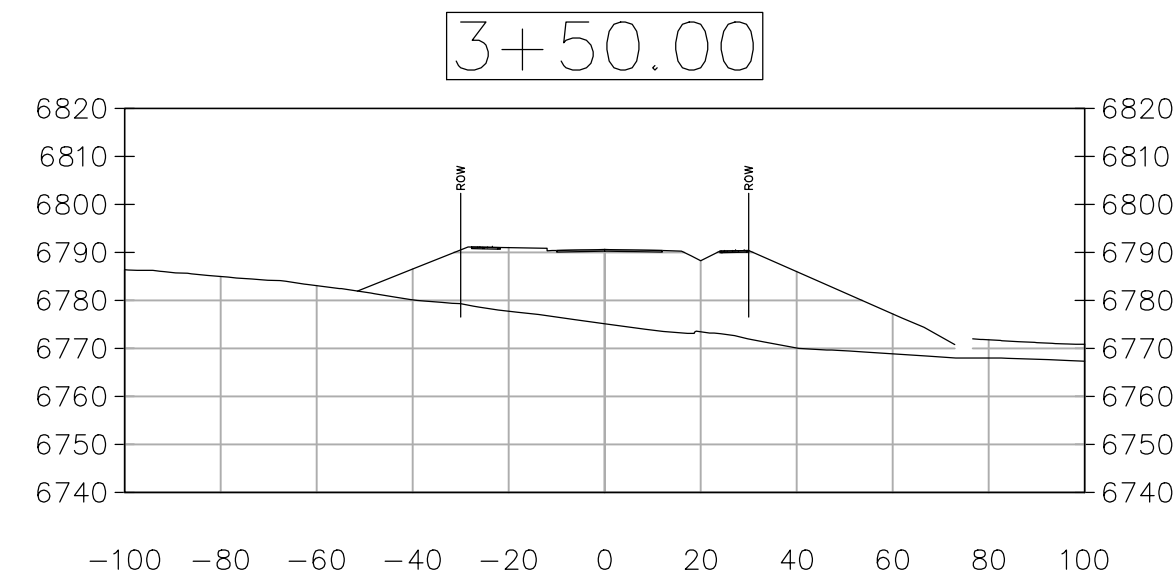
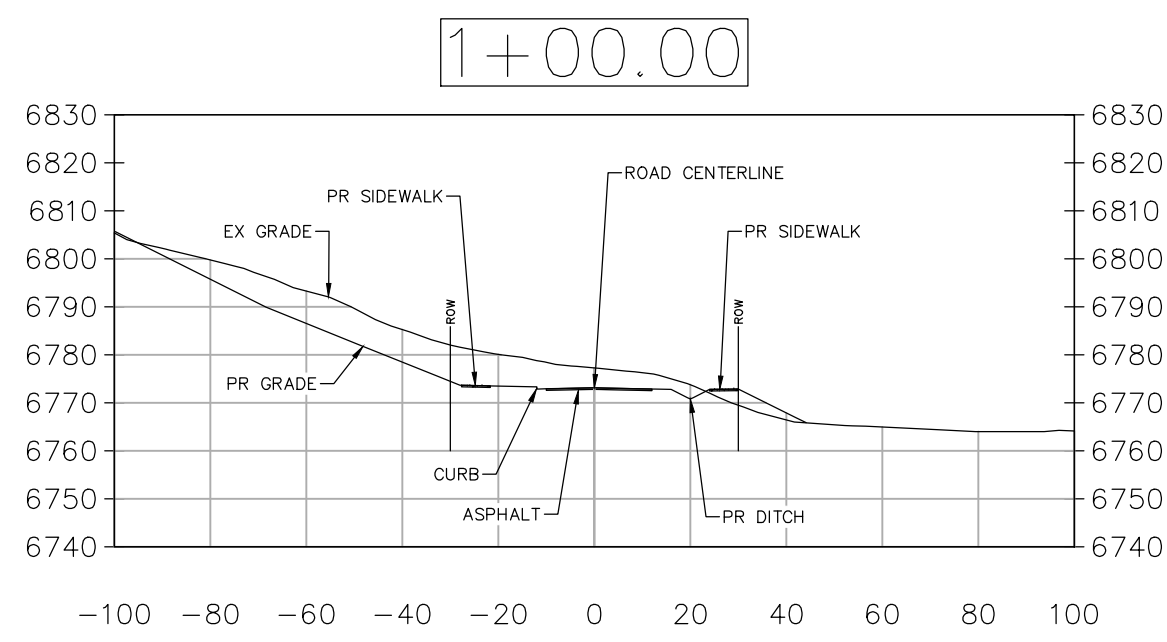
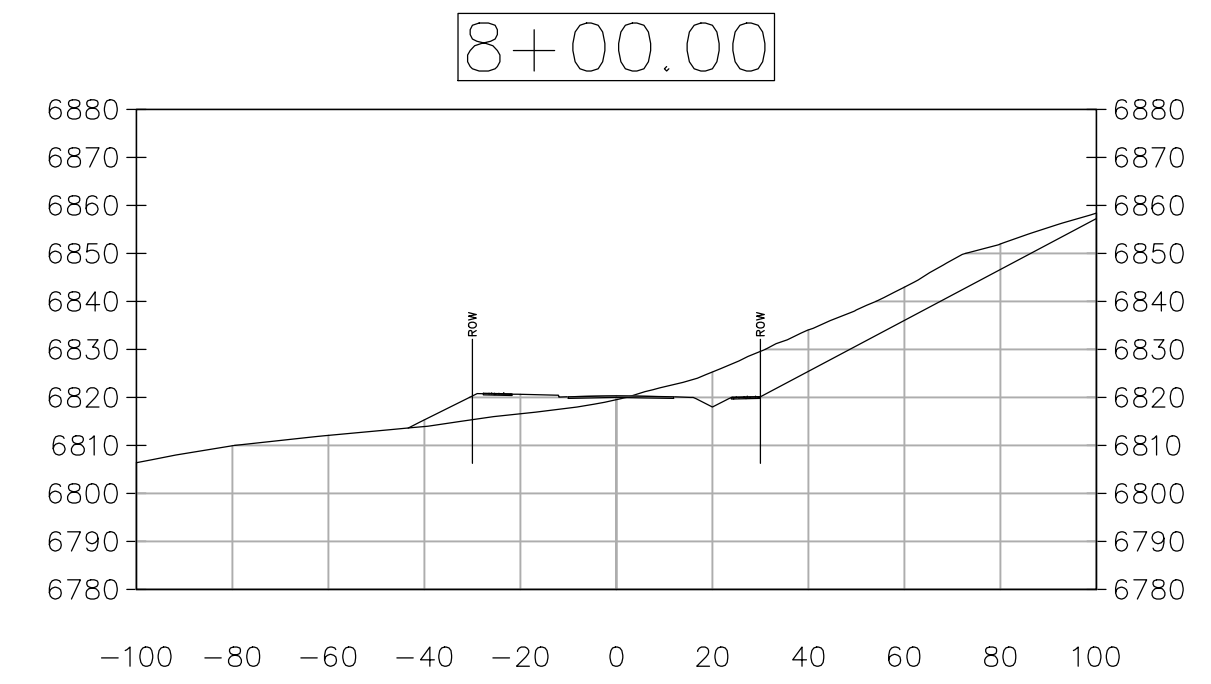
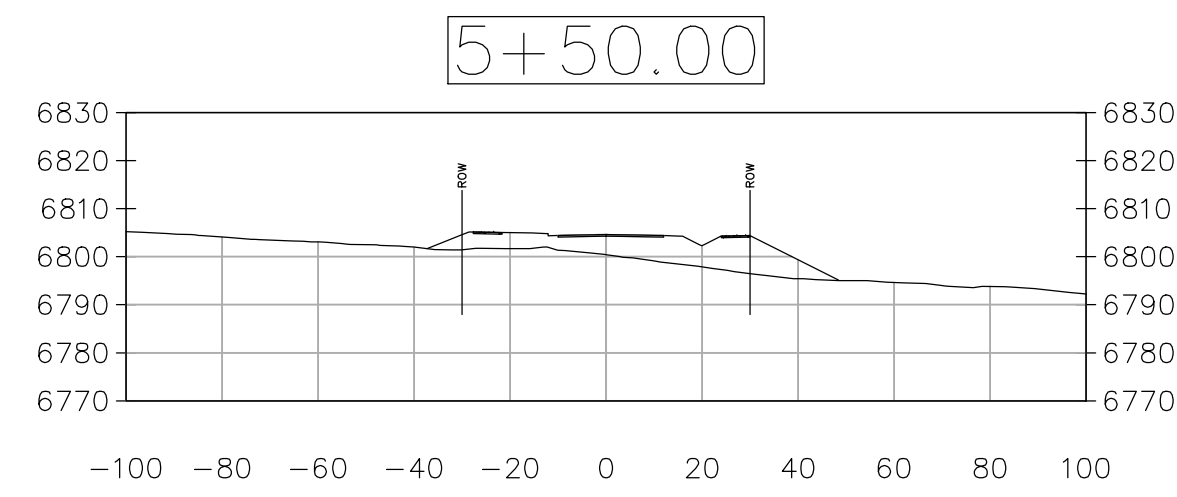
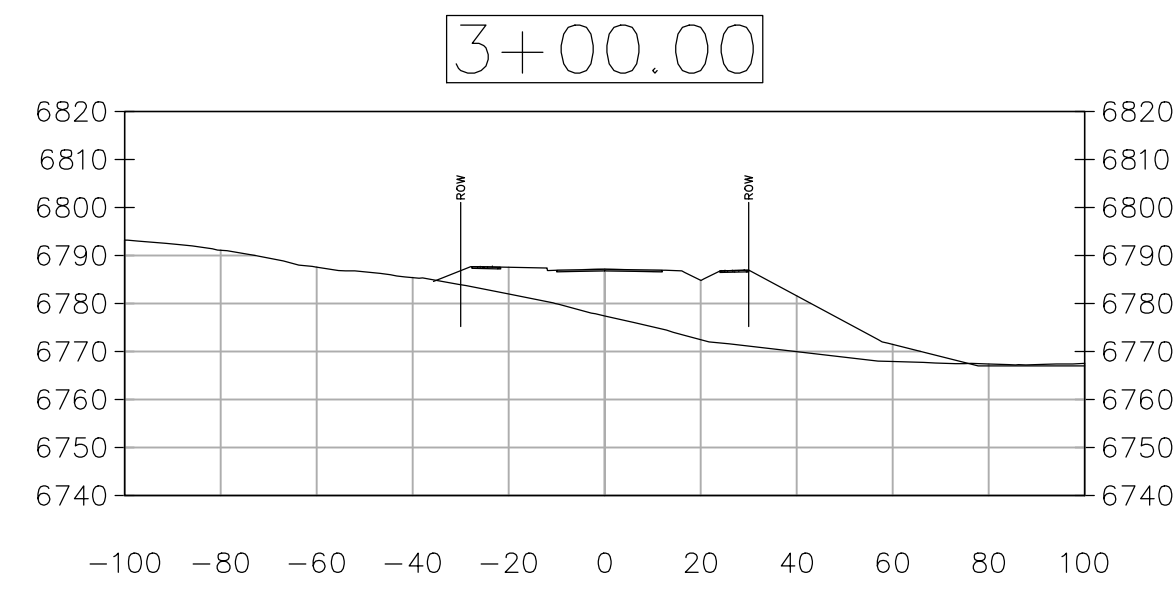
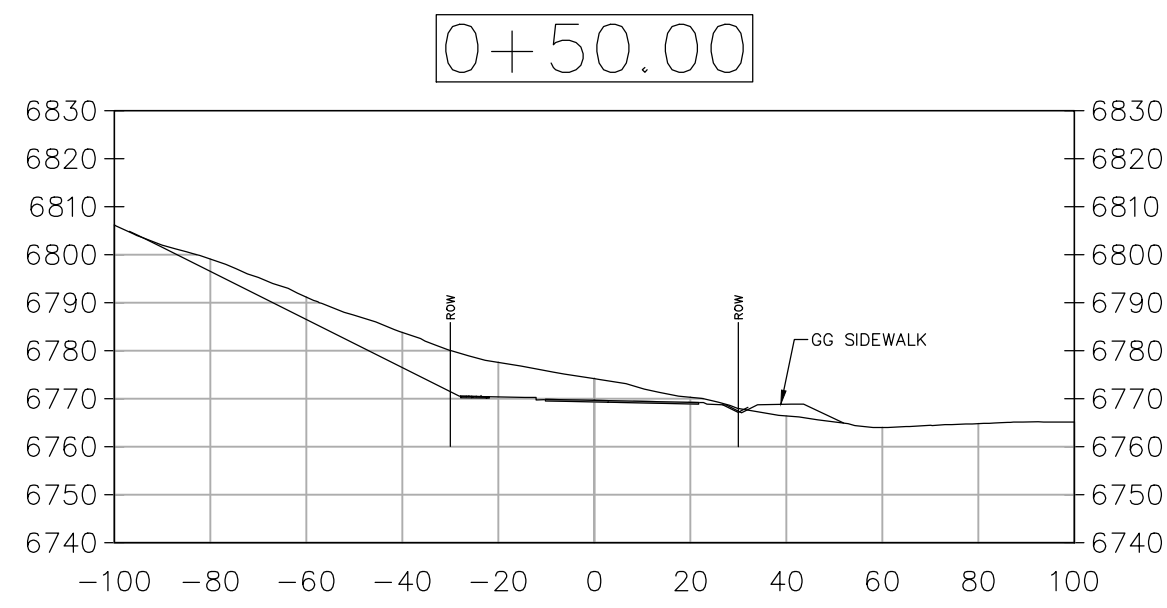
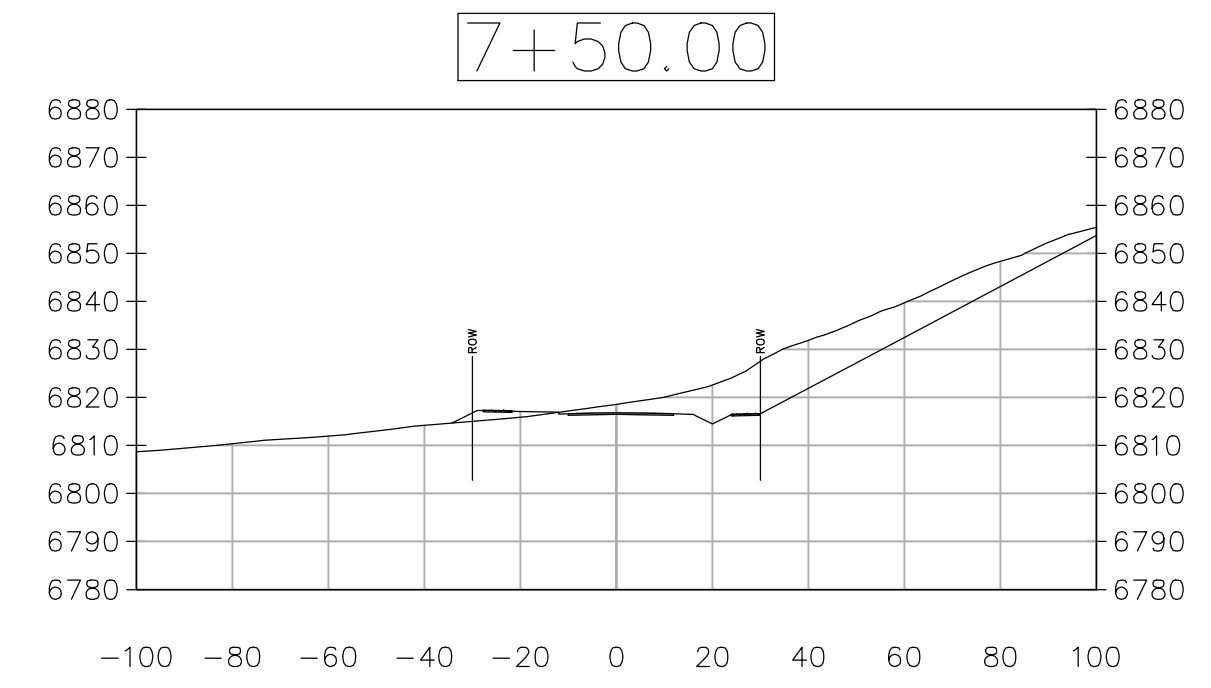
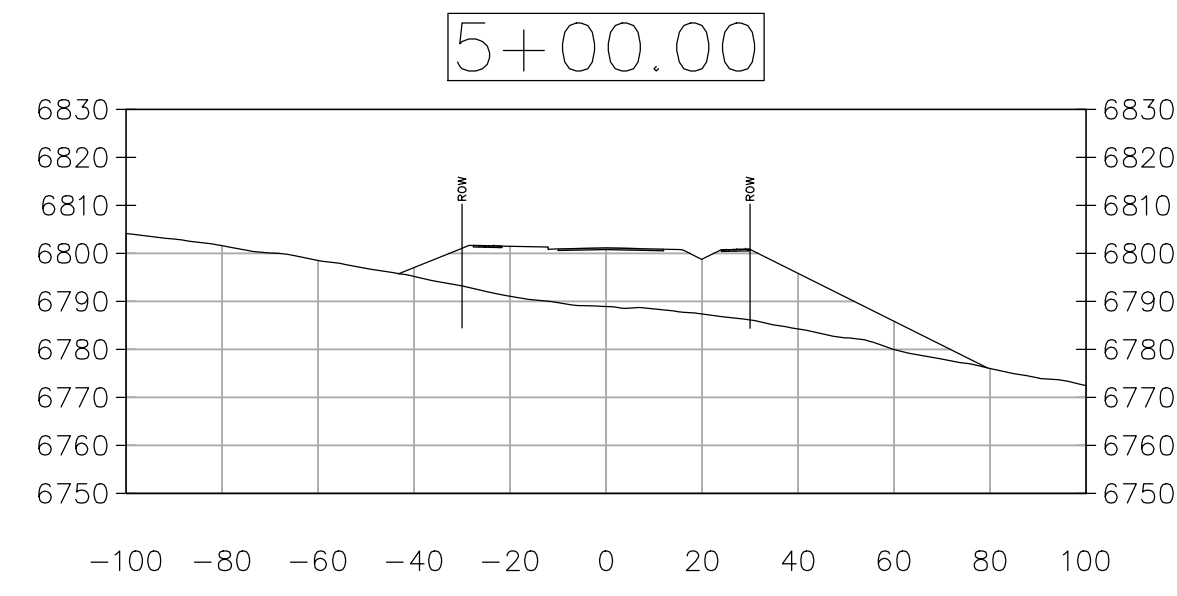
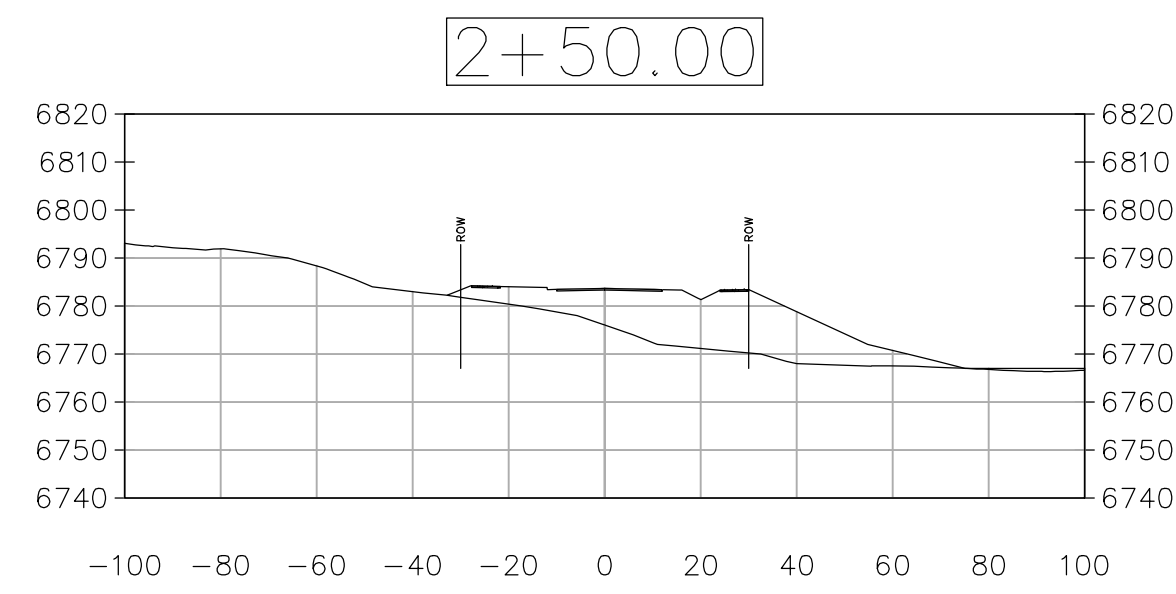
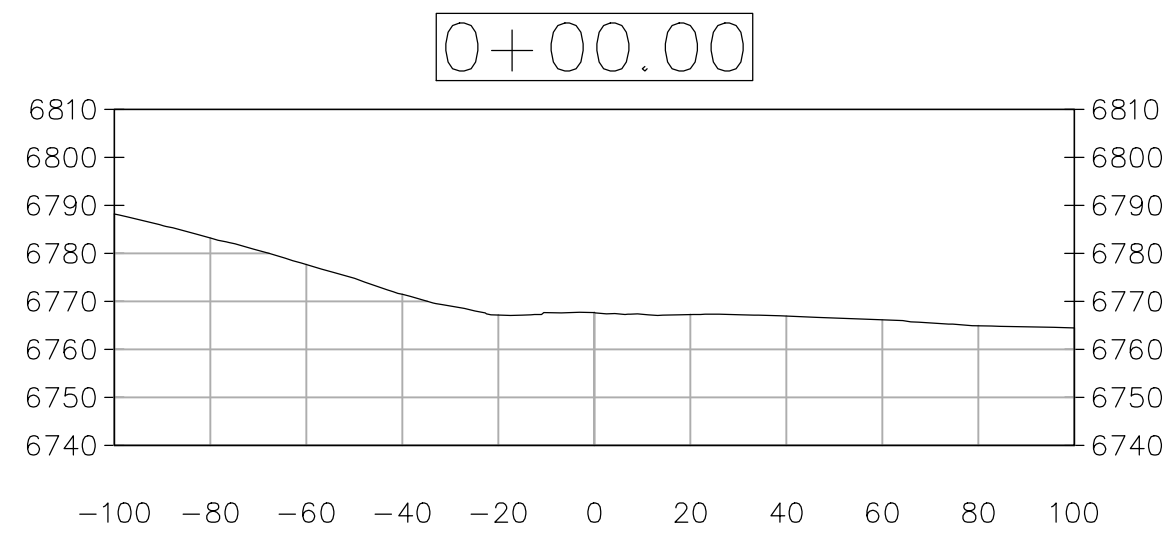

No.	DATE	REVISIONS	
		DESCRIPTION	BY
1	9/2/2022	DRT REVIEW & RESPONSE	MDM
2	6/16/2023	DRT REVIEW & RESPONSE	MDM

**STEAMBOAT AIRPARK
PRELIMINARY PLAT
LOT 1, WEST ACRES RANCH SUBDIVISION
GLORIA GOSSARD PARKWAY
STEAMBOAT SPRINGS, CO 80487**

Horizontal Scale

1" = 40'
Contour Interval = 2 ft
DATE: 4-22-2022
JOB #: 1670-001
DRAWN BY: MDM
DESIGN BY: MDM
REVIEW BY: RL

IF THIS DRAWING IS PRESENTED IN A
FORMAT OTHER THAN A3 X 36", THE
GRAPHIC SCALE SHOULD BE UTILIZED.

**DRAWING:
COPPER RIDGE
VILLAGE DRIVE
STORM PROFILES**

**SHEET #
PP13**

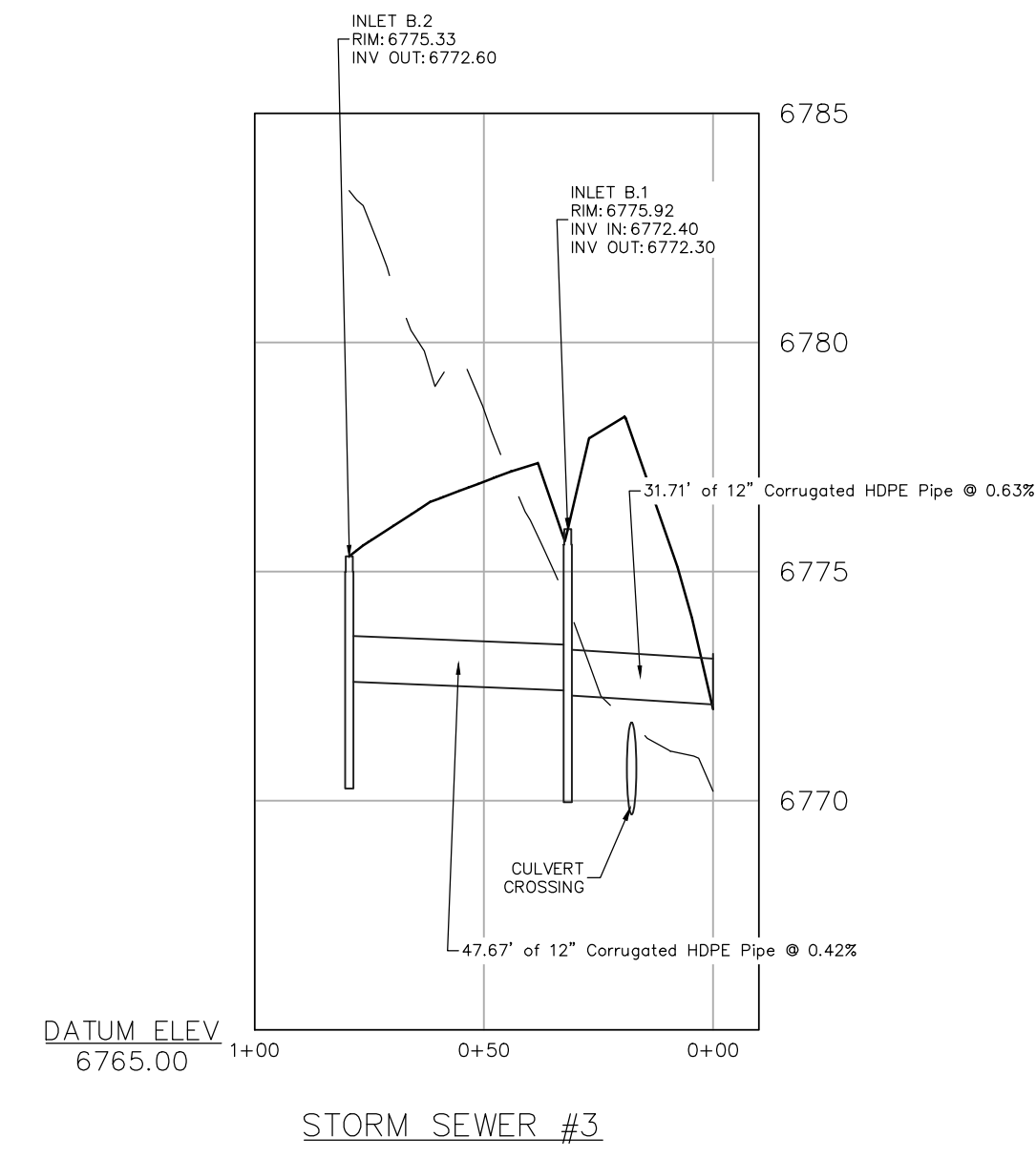
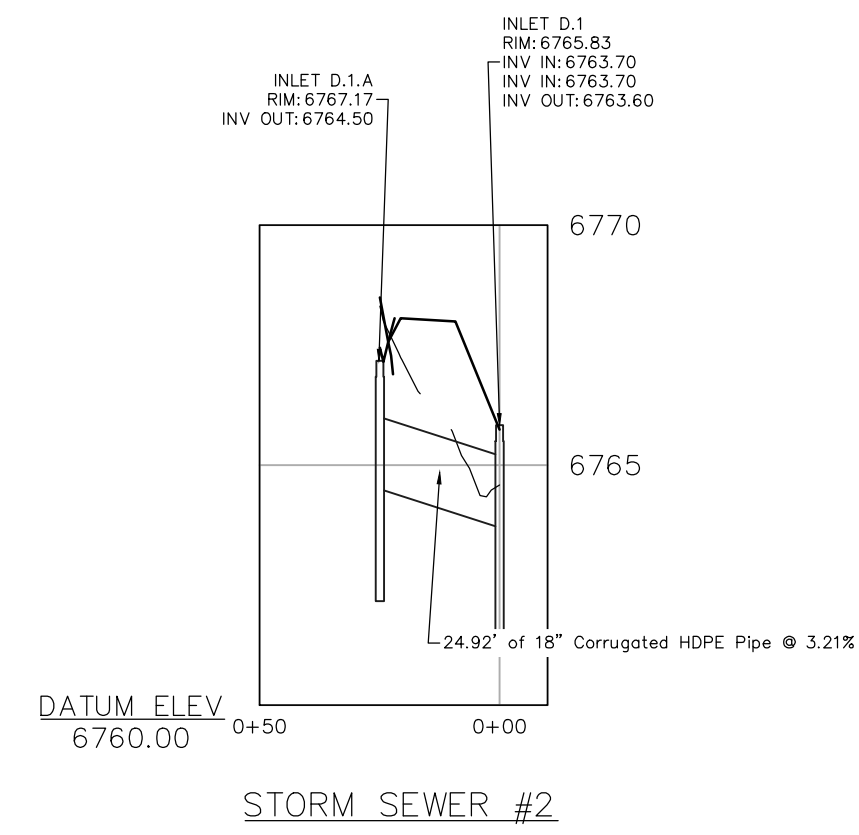
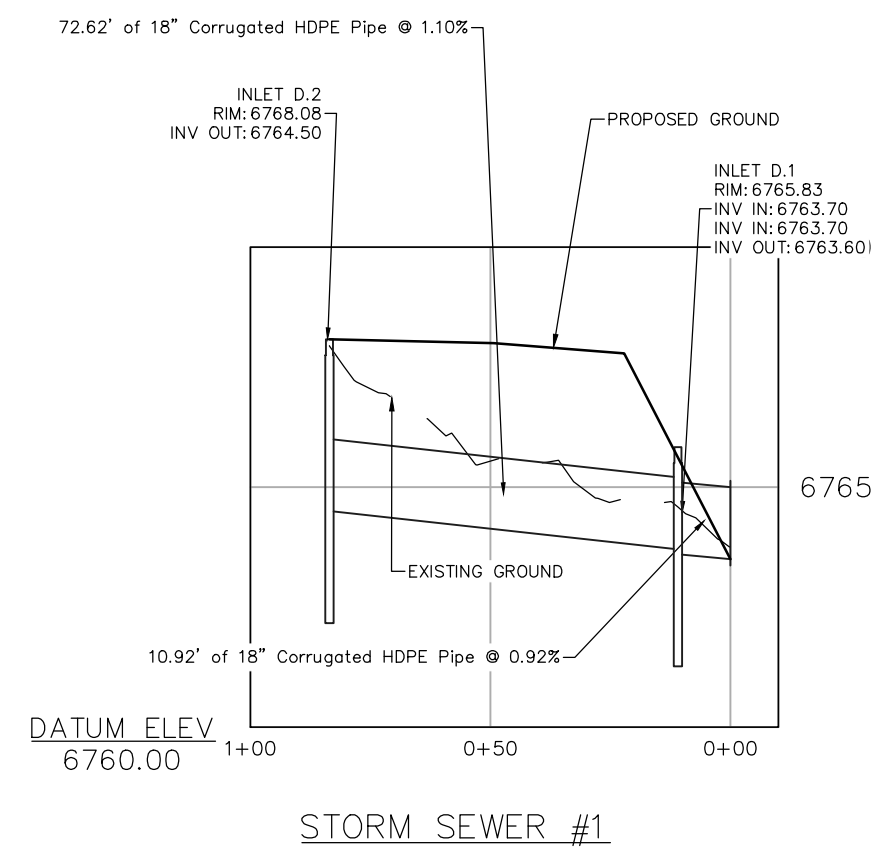

NOTE: SEE PAGE PP10 FOR INLET DETAIL.

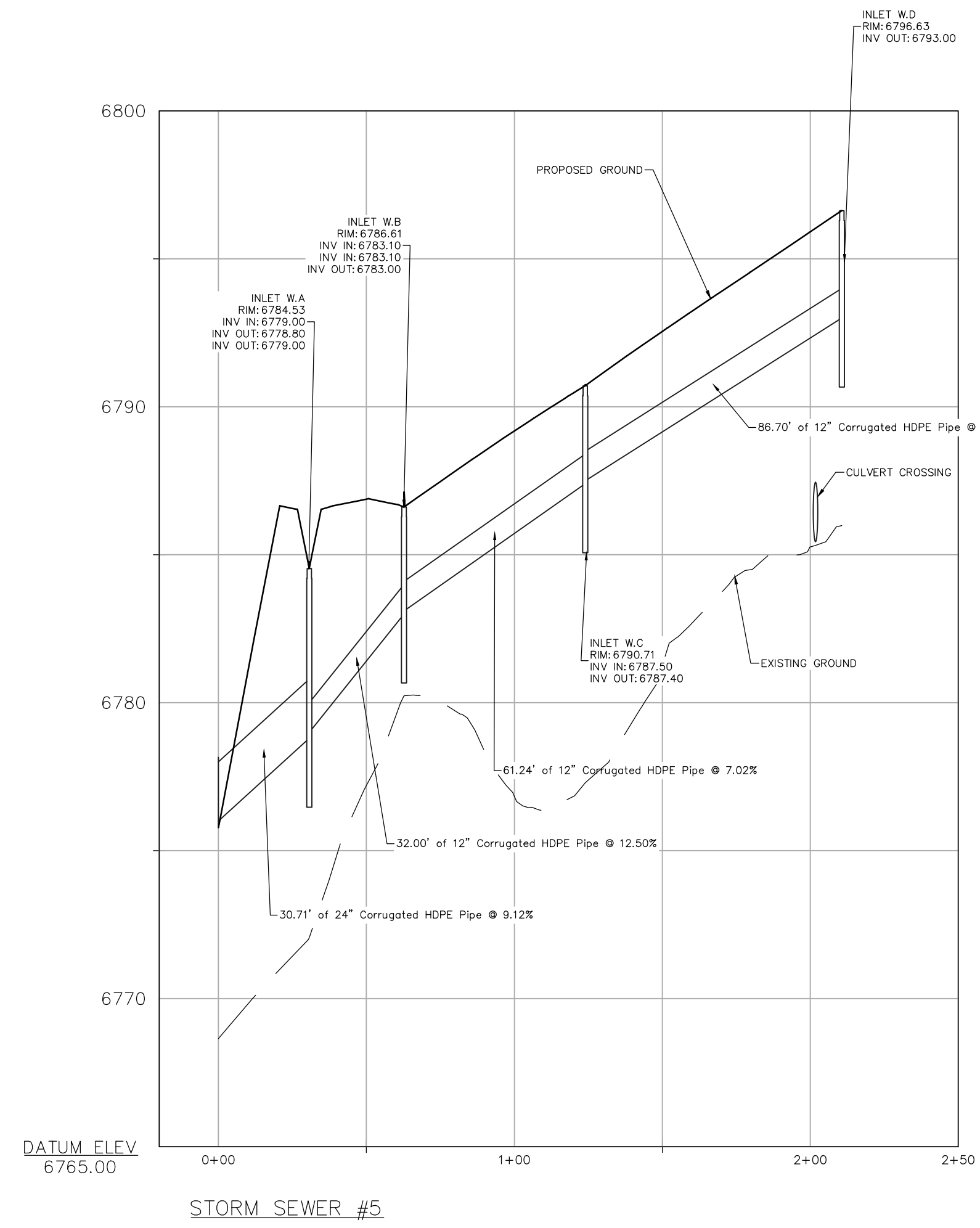
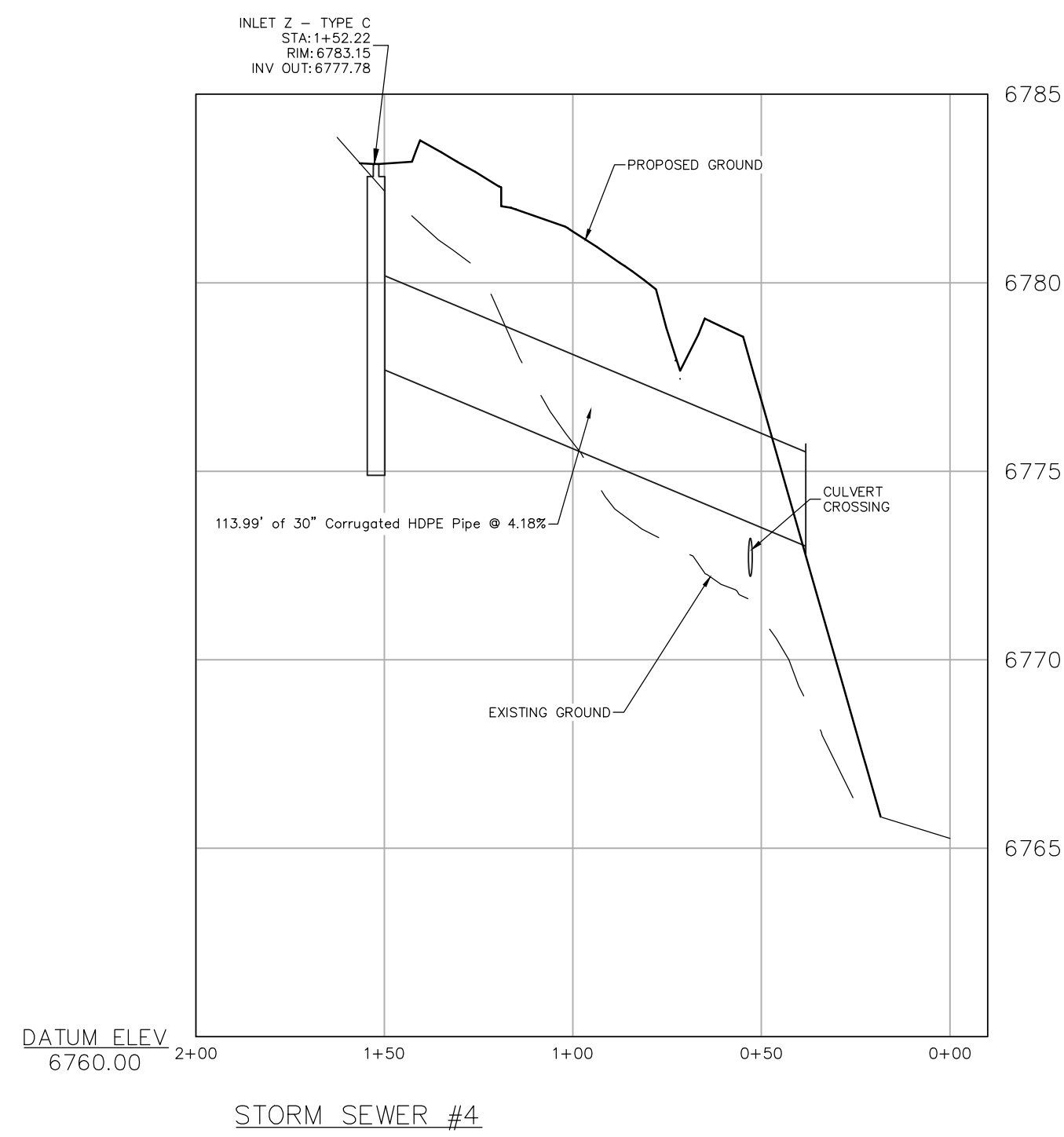



440 S. Lincoln Ave, Suite 4A
 P.O. Box 775966
 Steamboat Springs, CO 80487
 (970)-871-6772
 www.fourpointse.com

No.	DATE	REVISIONS
1	3/13/2023	DRT REVIEW & RESPONSE
2	6/16/2023	DRT REVIEW & RESPONSE

**STEAMBOAT AIRPARK
 PRELIMINARY PLAT
 LOT 1, WEST ACRES RANCH SUBDIVISION
 GLORIA GOSSARD PARKWAY
 STEAMBOAT SPRINGS, CO 80487**

Horizontal Scale

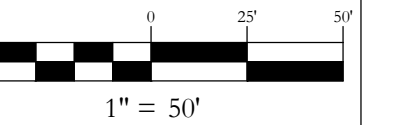

Contour Interval = 2 ft

DATE: 4-22-2022
 JOB #: 1670-001
 DRAWN BY: MDM
 DESIGN BY: MDM
 REVIEW BY: RL

IF THIS DRAWING IS PRESENTED IN A
 FORMAT OTHER THAN 24" X 36", THE
 GRAPHIC SCALE SHOULD BE UTILIZED.

**DRAWING:
 GLORIA GOSSARD
 PLAN & PROFILE
 STA 5+42 TO 10+00**

**SHEET #
 PP14**

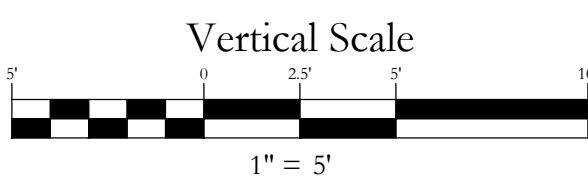
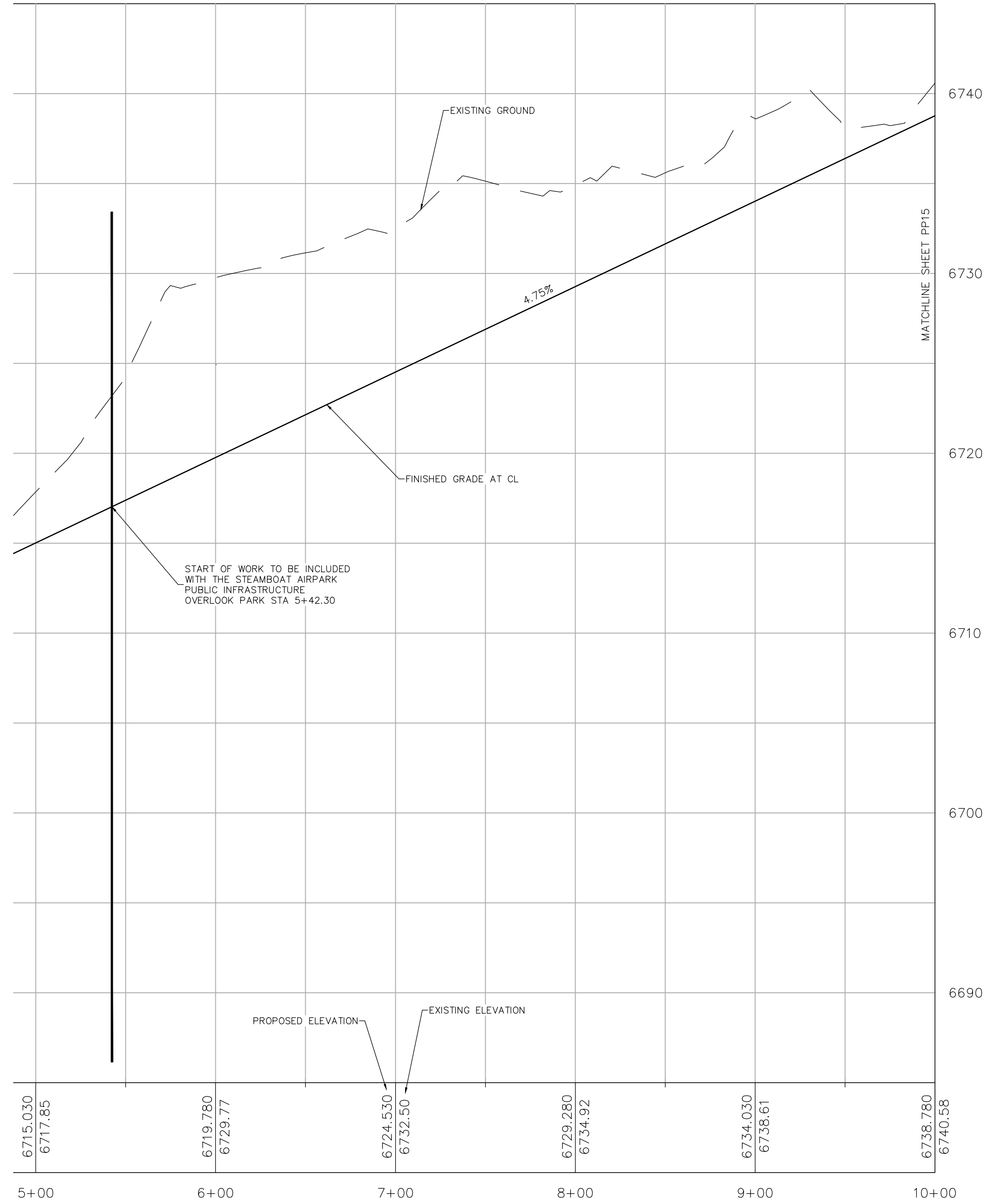
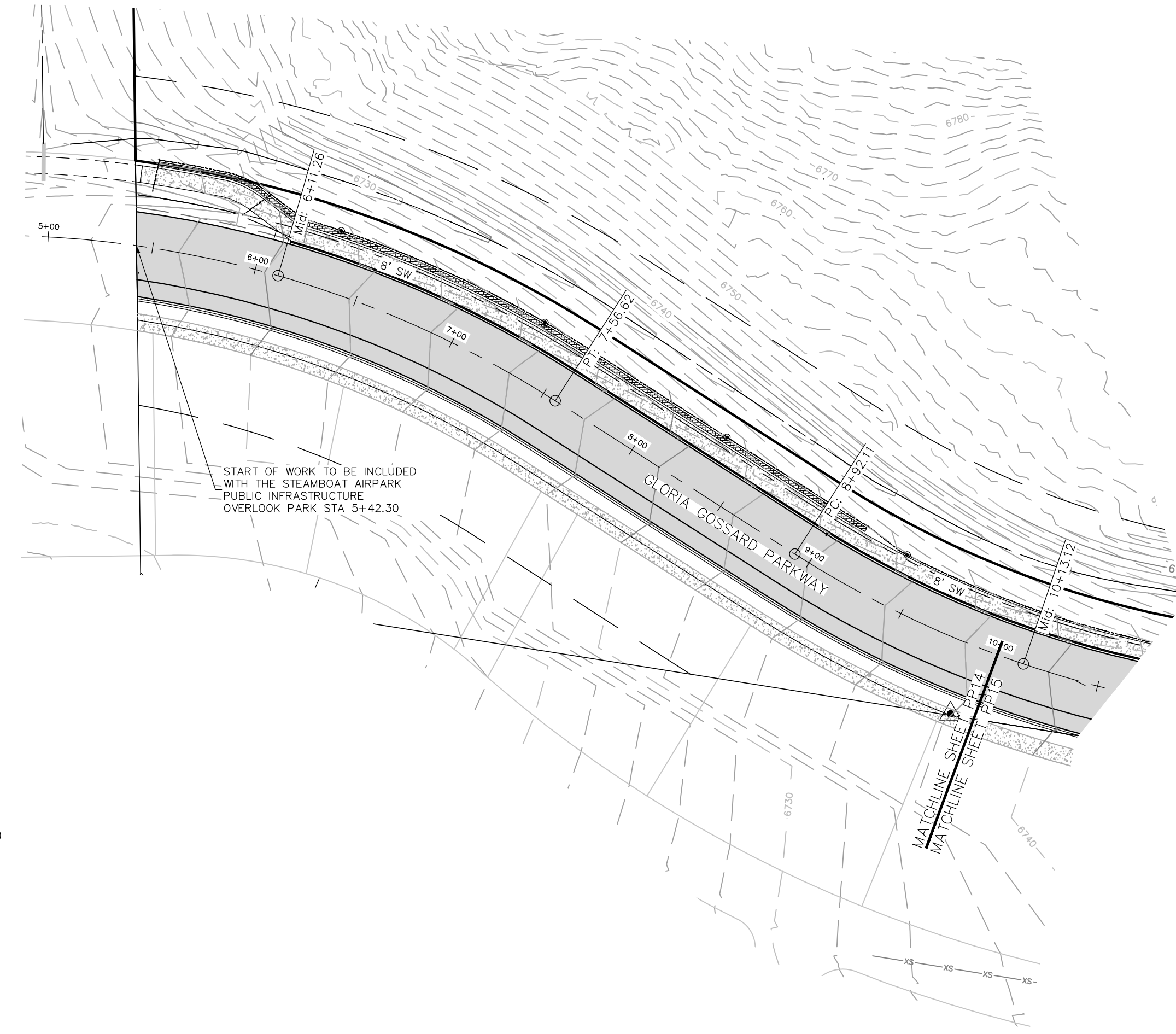

IF THIS DRAWING IS PRESENTED IN A FORMAT OTHER THAN
 24" X 36", THE GRAPHIC SCALE SHOULD BE UTILIZED.

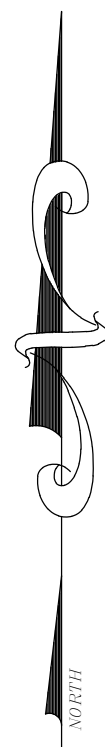

No.	DATE	REVISIONS	
		INT	MDM
1	3/13/2023	DRT	REVIEW & RESPONSE
2	6/16/2023	DRT	REVIEW & RESPONSE

**STEAMBOAT AIRPARK
PRELIMINARY PLAN
LOT 1, WEST ACRES RANCH SUBDIVISION
GLORIA GOSSARD PARKWAY
STEAMBOAT SPRINGS, CO 80487**

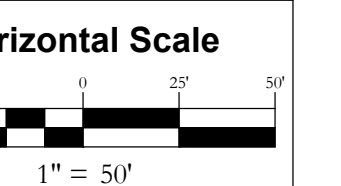

Contour Interval = 2 ft
DATE: 4-22-2022
JOB #: 1670-001
DRAWN BY: MDM
DESIGN BY: MDM
REVIEW BY: RL

IF THIS DRAWING IS PRESENTED IN A FORMAT OTHER THAN A4 X 36", THE GRAPHIC SCALE SHOULD BE UTILIZED.

DRAWING:
**GLORIA GOSSARD
PLAN & PROFILE
STA 10+00 TO 16+50**

SHEET #
PP15

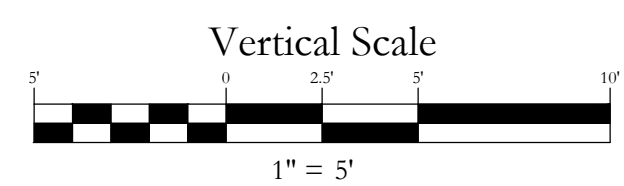
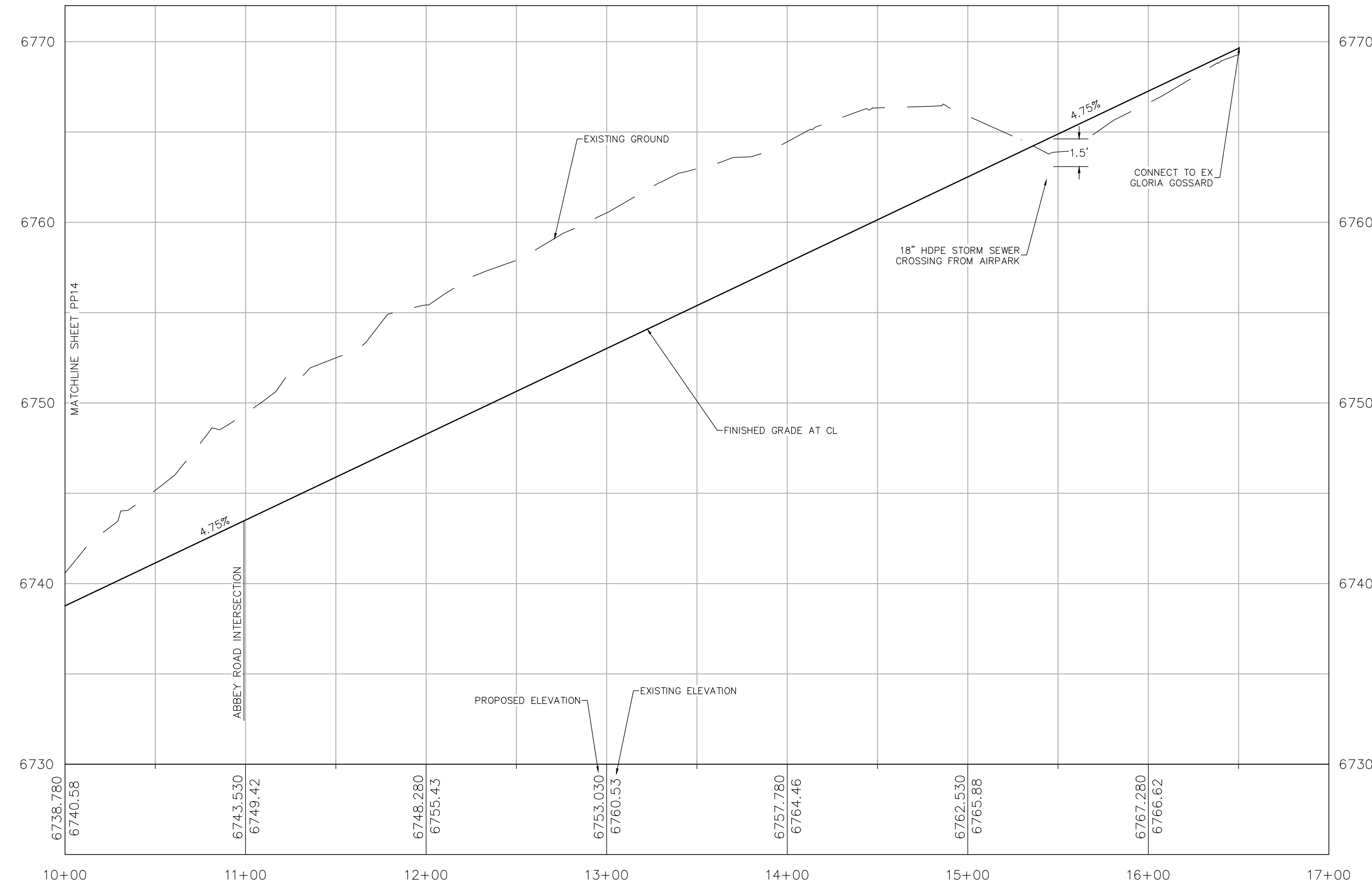
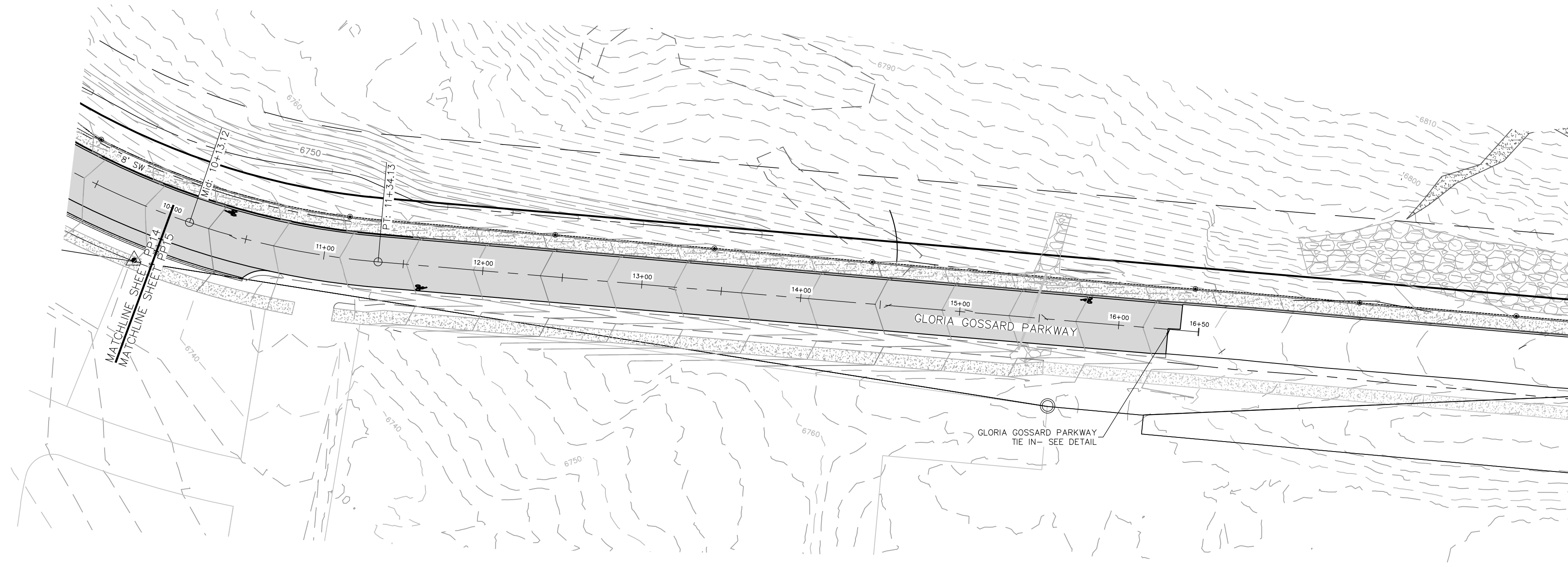

IF THIS DRAWING IS PRESENTED IN A FORMAT OTHER THAN 24" X 36", THE GRAPHIC SCALE SHOULD BE UTILIZED.

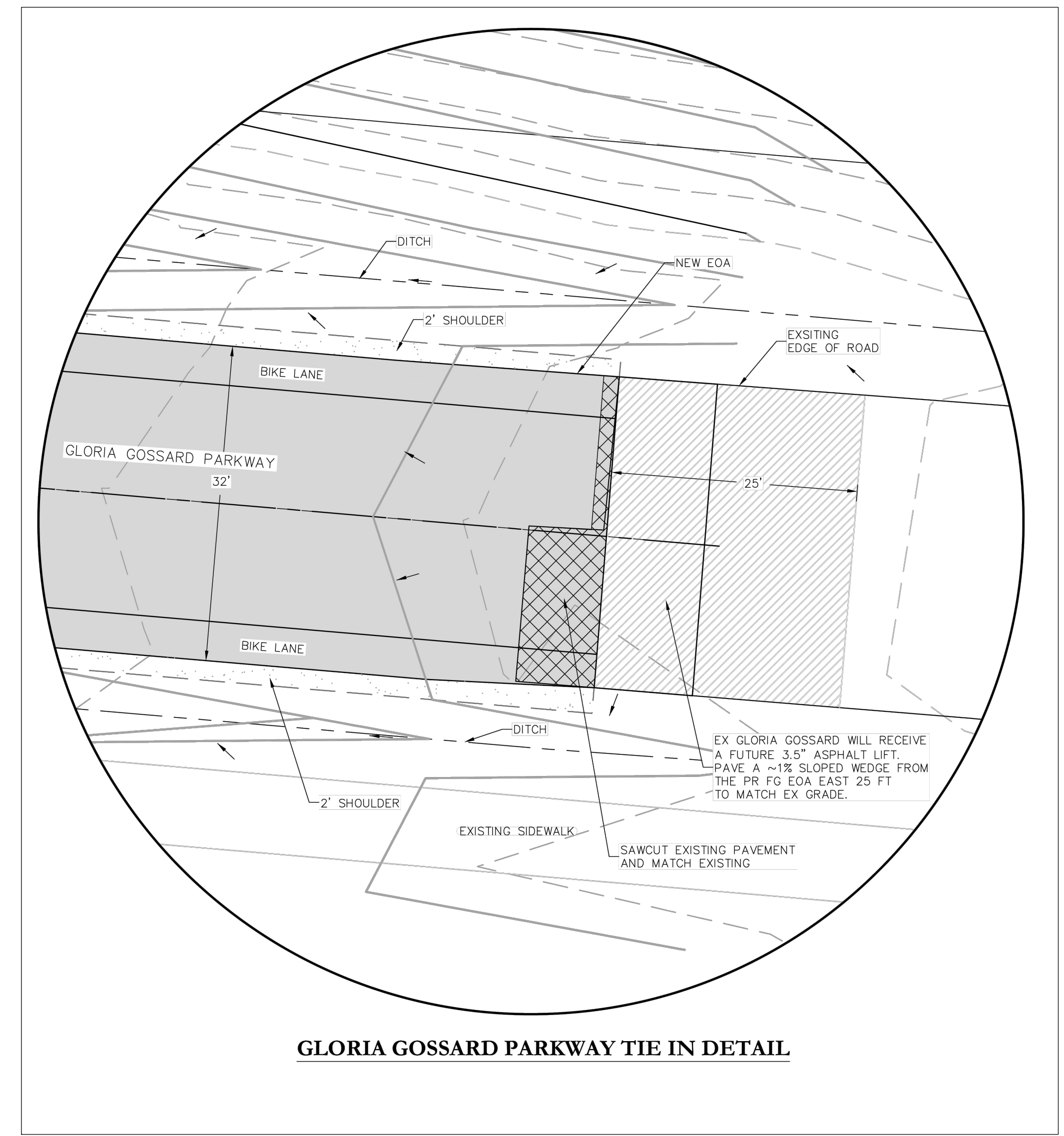

GLORIA GOSSARD PARKWAY TIE IN DETAIL

